

SMB Bearings

Radial Ball Bearing

Part Number: 6809ZZ



(for illustration only)

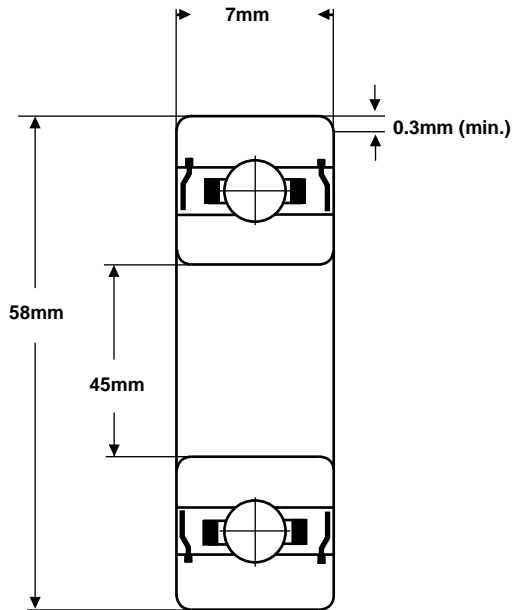

Material (rings & balls)	SAE52100 chrome steel
Material (cage)	pressed steel
Closures	Metal shields
Load rating (stat)	538 Kgf
Load rating (dyn)	618 Kgf
Speed Limit *	10,000 rpm
Standard Lubrication **	Kyodo Yushi Multemp SRL grease

* with adequate lubrication

** may vary

These bearings comply with EU ROHS and REACH regulations.

RADIAL PLAY	C2	CN	C3	C4
(microns)	1 - 11	6 - 23	18 - 36	30 - 51

TOLERANCE	P0	P6	P5
Bore Deviation	+0 / -0.012mm	+0 / -0.010mm	+0 / -0.008mm
OD Deviation	+0 / -0.013mm	+0 / -0.011mm	+0 / -0.009mm
Width Deviation	+0 / -0.120mm	+0 / -0.120mm	+0 / -0.120mm
Single Bore Variation	15	13	8
Single OD Variation	16	14	9
Inner Width Variation	20	20	5
Outer Width Variation	20	20	5
Inner Radial Runout	15	10	5
Outer Radial Runout	25	13	8

SMB Bearings take no responsibility for any errors or omissions in this data sheet. We reserve the right to change specifications without prior notice. We recommend that adequate testing is carried out on products before they are determined as suitable for an application.