

SMB Bearings

Radial Ball Bearing

Part Number: AC689-GL



(for illustration only)

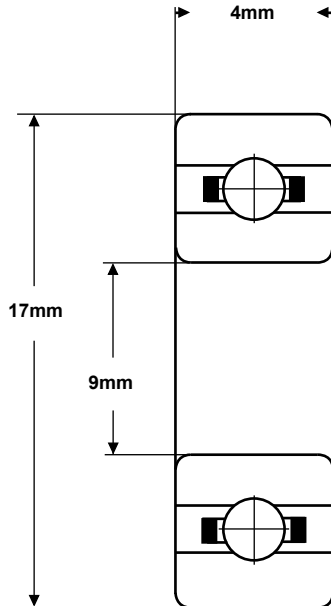

Material (rings)	Acetal Resin (POM)
Material (balls)	Glass
Material (cage)	PA66 Nylon
Closures	None
Load rating (stat)	5 Kgf
Load rating (dyn)	7 Kgf
Speed Limit	2,600 rpm

These bearings comply with EU ROHS and REACH regulations.

TOLERANCE	
Bore Deviation	+/-0.1mm
OD Deviation	+/-0.1mm
Width Deviation	+/-0.5mm

**** Please note, plastic bearings are semi-precision**

SMB Bearings take no responsibility for any errors or omissions in this data sheet. We reserve the right to change specifications without prior notice. We recommend that adequate testing is carried out on products before they are determined as suitable for an application.