

# SMB Bearings

# Radial Ball Bearing

## Part Number: CCZR-688



(for illustration only)

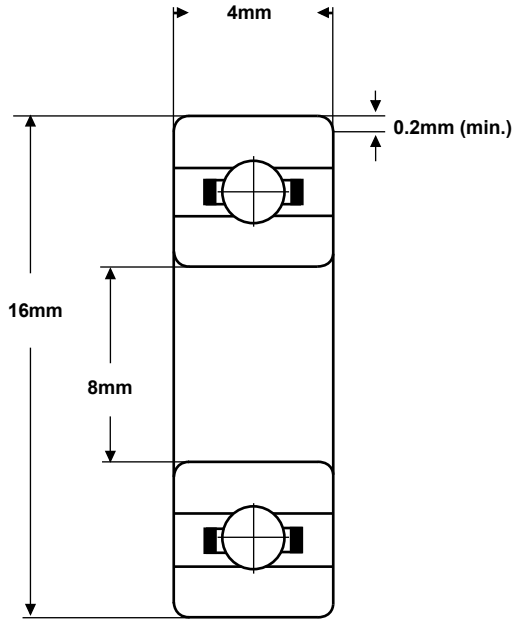

<b>Material (rings &amp; balls)</b>	Zirconium dioxide (ZrO <sub>2</sub> )
<b>Material (cage)</b>	Full complement, PEEK or PTFE
<b>Closures</b>	None
<b>Load rating (stat)</b>	44 Kgf
<b>Load rating (dyn)</b>	94 Kgf
<b>Speed Limit *</b>	9,000 rpm
<b>Standard Lubrication **</b>	None

\* with adequate lubrication  
 \*\* may vary

**These bearings comply with EU ROHS and REACH regulations.**

<b>RADIAL PLAY</b>	<b>C2</b>	<b>CN</b>	<b>C3</b>	<b>C4</b>
(microns)	0 - 7	2 - 13	8 - 23	14 - 29

<b>TOLERANCE</b>	<b>P0</b>
<b>Bore Deviation</b>	+0 / -0.008mm
<b>OD Deviation</b>	+0 / -0.008mm
<b>Width Deviation</b>	+0 / -0.120mm

SMB Bearings take no responsibility for any errors or omissions in this data sheet. We reserve the right to change specifications without prior notice. We recommend that adequate testing is carried out on products before they are determined as suitable for an application.